

LABCONCEPT + Premium



LABCONCEPT + Premium

INTRODUCTION

The Labconcept and Labconcept Premium are high precision calibration systems that meet the most sophisticated requirements.

The up-to-date, well designed modular concept enables extremely secure functioning, facilitates the manipulation and therefore increases the productivity in the measuring laboratory. Simplicity and high accuracy have been associated.

This new concept, integrating a computer and a touch screen as well as the appropriate Trimos-WinDHI software with all necessary measuring functions guarantees the best results. A temperature compensation system as well as a gauge management system can be installed to enhance the system performance.

Instruments with a measuring range from 300 to 2000 mm are available, all made in one single piece. All measuring ranges being direct, it means that the whole measuring range is available without adjustment or intermediate re-calibration.

MEETS THE REQUIREMENTS OF ALL EN ISO 9000

PC WITH EXCLUSIVE SOFTWARE WINDHI

HIGH PRECISION MEASURING SYSTEM

DIMENSIONALLY STABLE INSTRUMENT BASE

ADJUSTABLE MEASURING FORCE (FROM 0 TO 12 N)

LARGE RANGE OF ACCESSORIES

DIRECT MEASUREMENT OVER THE WHOLE
MEASURING RANGE

DESCRIPTION

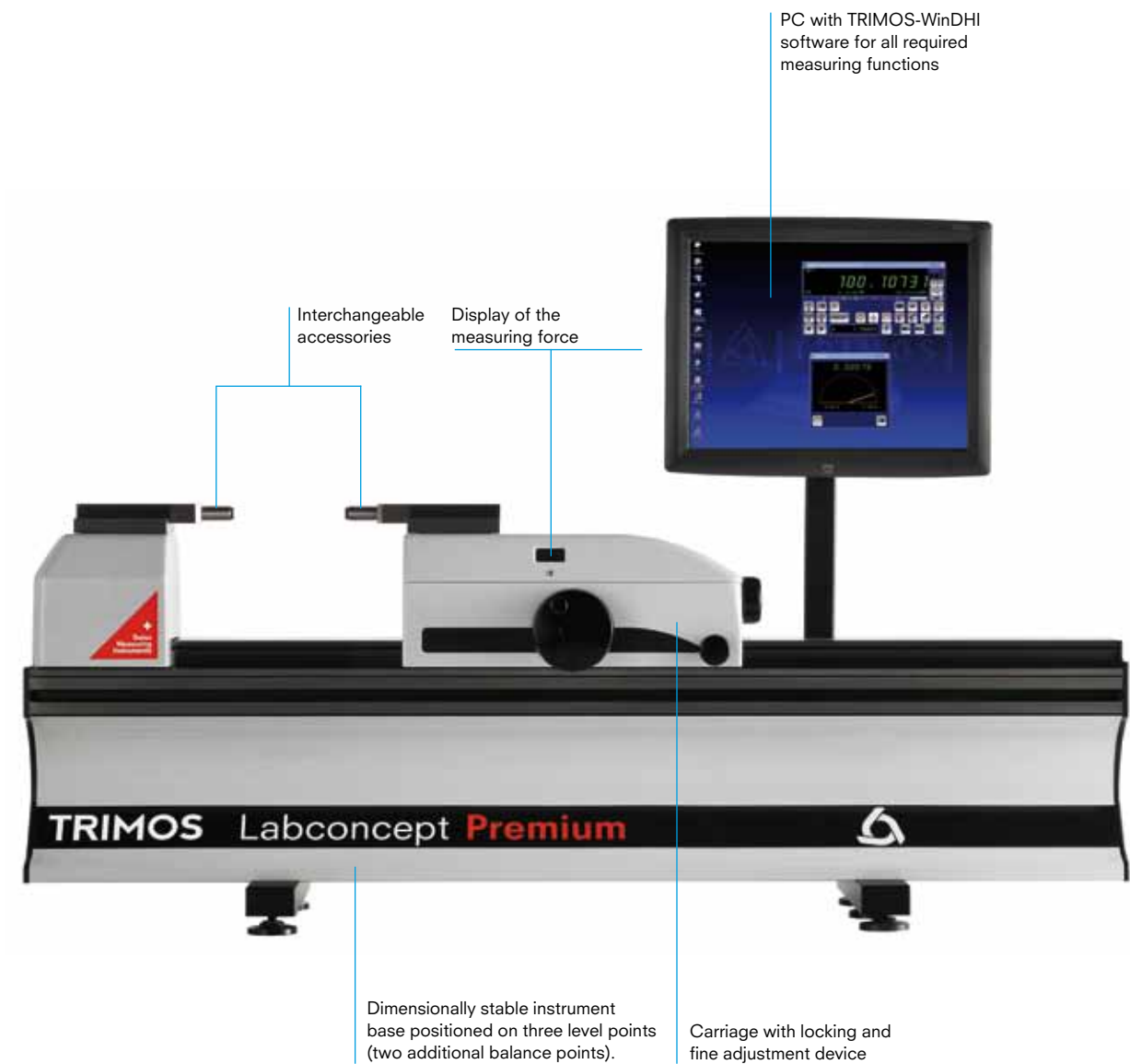

LABCONCEPT + Premium

DISPLAY / SOFTWARE

TRIMOS WINDHI

TRIMOS® WinDHI Software allows the performance of all required measuring functions. It can be connected to the temperature compensation software WinComp and to any gauge inspection and management program.



DDE-SERVER (FOR EXCEL, WORD, ETC.)

GRAPHIC HELP FOR MEASURING FUNCTIONS

DATA TRANSFER USING A FOOT PEDAL

DIGITAL DISPLAY OF THE SELECTED MEASURING FORCE IN NEWTON (N)

DIRECT DISPLAY OF ALL LENGTH MEASURING VALUES AND MINI/MAX VALUE HOLD

INPUT OF 9 PRESET VALUES

INVERSION OF MEASURING DIRECTION SIGN (+/-)

COMPATIBLE WITH TEMPERATURE COMPENSATION SYSTEM TEMPCOMP

QMSOFT

Trimos recommends the QMSOFT software package for inspection and management of all measuring tools available.

INTEGRATED DRIVERS FOR TRIMOS INSTRUMENTS

REQUIRED NOMINAL SIZES AND TOLERANCES AVAILABLE ACCORDING TO ALL STANDARDS

CUSTOMIZED INSPECTION CERTIFICATES



DISPLAY / SOFTWARE

TEMPERATURE COMPENSATION SYSTEM TRIMOS TEMPCOMP

The Temperature Compensation System TempComp gives a solution to air conditioning problems in measuring laboratories.

COMPATIBLE WITH HPD, LABCONCEPT, LABCONCEPT PREMIUM AND LABCONCEPT NANO INSTRUMENTS

TRIMOS WINCOMP EXCLUSIVE SOFTWARE

ACQUISITION AND MANAGEMENT OF TEMPERATURE DATA

PERMANENT CONNECTION WITH WIN DHI

REAL-TIME COMPENSATION OF THE MEASUREMENT

TEMPERATURE EVOLUTION HISTORY OVER SEVERAL YEARS FOR A PERFECT TRACEABILITY

GRAPHICAL DISPLAY OF TEMPERATURE EVOLUTION

MATERIALS LIBRARY

INDICATION OF THE MEASUREMENT RELIABILITY LEVEL

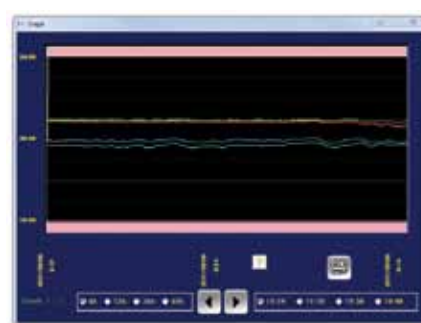

TEMPCOMP BASIC

BASIC TEMPERATURE COMPENSATION SYSTEM

2 TEMPERATURE SENSORS:

A PART TO BE MEASURED
B MEASURING CARRIAGE

TEMPCOMP PREMIUM

PART TO BE MEASURED

3 TEMPERATURE SENSORS:

A PART TO BE MEASURED
B MEASURING CARRIAGE
C INSTRUMENT BASE

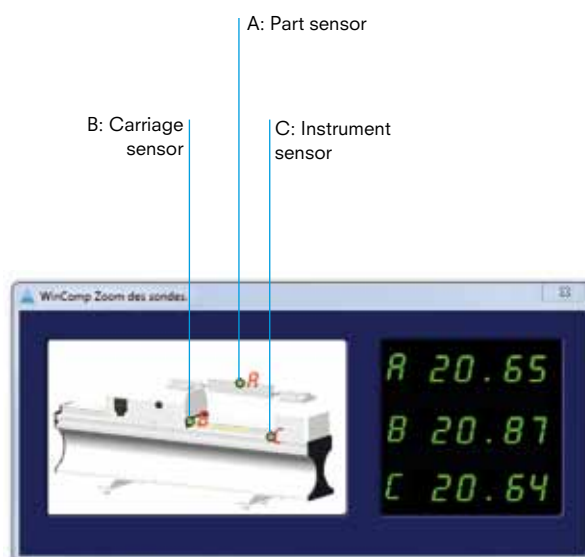

TempComp Basic & Premium		
Application range (temperature)	°C	+16 ÷ +24
Max. resolution (temperature)	°C	0.01
Max. permissible errors (temperature)	°C	0.05

LABCONCEPT + Premium

DISPLAY / SOFTWARE

TEMPCOMP ADVANCED

The environment control system TempComp Advanced represents an evolution of the temperature compensation system TempComp.

Tempcomp is an exclusive temperature compensation system with environmental parameter verification of the laboratory. The temperature acquisition is managed by WinComp Advanced software. It offers, on top of WinComp functionalities, the possibility to check the laboratory in real time via Internet, Intranet, mobile phone, etc..



INTEGRATED TEMPERATURE COMPENSATION SYSTEM FOR LABORATORY

3 TEMPERATURE SENSORS ON THE INSTRUMENT:

- PART TO BE MEASURED
- MEASURING CARRIAGE
- INSTRUMENT BASE

4 TEMPERATURE SENSORS IN THE LABORATORY

1 RELATIVE HUMIDITY SENSOR

1 ATMOSPHERIC PRESSURE SENSOR

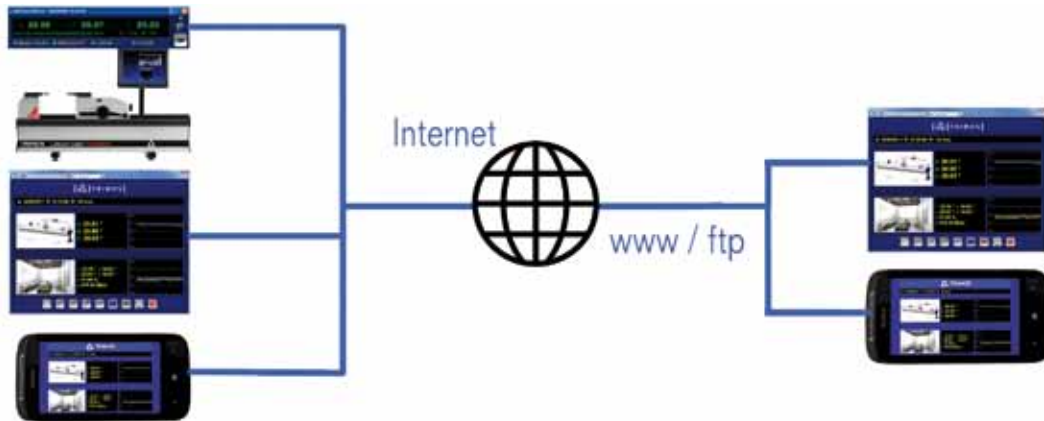

TempComp Advanced		
Application range (temperature)	°C	+16 ÷ +24
Max. resolution (temperature)	°C	0.01
Max. permissible errors (instrument temperature)	°C	0.05
Max. permissible errors (environmental temperature)	°C	0.16
Max. permissible errors (humidity)	%	± 2
Max. permissible errors (pressure)	mbar	± 0.5 %

TECHNICAL SPECIFICATIONS

Labconcept		500	1000	1500	2000
Measuring range	mm (in)	550 (21)	1050 (41)	1550 (61)	2050 (80)
Max. permissible errors ¹⁾	µm	0.3 + L (mm) / 1500			
Repeatability (2s) ¹⁾	µm	0.1			
Resolutions	mm (in)	0.01 ÷ 0.00001 (.0001 ÷ .000001)			
Max. displacement speed	mm/s	1500			
Measuring force	N	0 ÷ 12			
Operational temperature	°C	+10 ÷ +40			
Temperature of storage	°C	-10 ÷ +40			
Relative humidity	%	20 ÷ 80			
Weight	kg	94	123	152	181

¹⁾ Values valid at temperature of 20 ± 0.2 °C and relative humidity of 50 ± 5%.

Labconcept Premium		300	500	1000
Measuring range	mm (in)	370 (14)	550 (21)	1050 (41)
Max. permissible errors ¹⁾	µm	0.1 + L (mm) / 2000	0.15 + L (mm) / 2000	
Repeatability (2s) ¹⁾	µm	0.05		
Resolutions	mm (in)	0.01 ÷ 0.00001 (.0001 ÷ .000001)		
Max. displacement speed	mm/s	400		
Measuring force	N	0 ÷ 12		
Operational temperature	°C	+10 ÷ +40		
Temperature of storage	°C	-10 ÷ +40		
Relative humidity	%	20 ÷ 80		
Weight	kg	78	95	125

¹⁾ Values valid at temperature of 20 ± 0.2 °C and relative humidity of 50 ± 5%.

SCHEMA

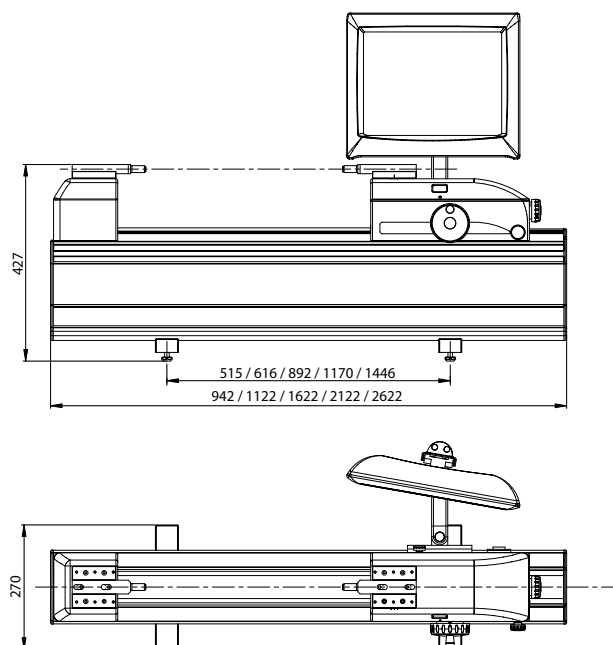

LABCONCEPT + Premium

STANDARD INSTRUMENT

The Labconcept and Labconcept Premium instruments are supplied as follows:
Instrument according to specifications
Pair of anvils with tungsten carbide surface (HPA-1)
PC with interface, touch screen ¹⁾ with adjustable support ¹⁾ and touch screen pen ¹⁾
Foot pedal for data transfer (TELMA31)
Opto-RS connection cable for measuring force (TVM.O-PC / AT.9P)
Lapping plate (TA-TO-302)
Protection cover (TEL.HO500 / 1000 / 1500 / 2000)
Allen key set (TA-TO-004)
User's manual (750 50 0015 03)
Test certificate

¹⁾ Not included in versions LABC-B. Touch screen replaced by a regular TFT screen.

CODE NUMBER

With touch screen	With TFTscreen	Labconcept
LABC500 700 203 10 01	LABC500B 700 203 10 02	Measuring range 500 mm
LABC1000 700 203 20 01	LABC1000B 700 203 20 02	Measuring range 1000 mm
LABC1500 700 203 30 01	LABC1500B 700 203 30 02	Measuring range 1500 mm
LABC2000 700 203 40 01	LABC2000B 700 203 40 02	Measuring range 2000 mm

With touch screen	With TFTscreen	Labconcept Premium
	LABCP300B 700 203 10 13	Measuring range 300 mm
LABCP500 700 203 10 11	LABCP500B 700 203 10 12	Measuring range 500 mm
LABCP1000 700 203 20 11	LABCP1000B 700 203 20 12	Measuring range 1000 mm

APPLICATIONS

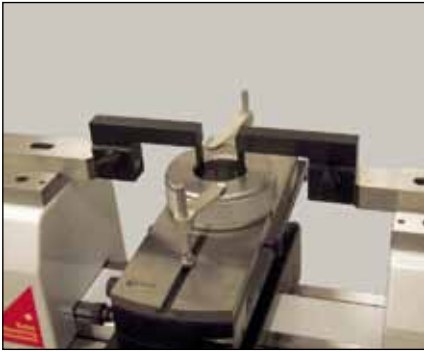

Calibration of ring gauges
(TA-SU-313/TEL16.1/HPA-1)

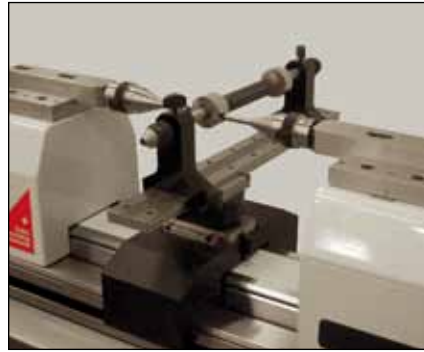

Calibration of plug gauges
(HPA-1/TULM6/L05/LABC-15)



Calibration of small ring gauges
(TA-SU-313/LABC-70/TA-SU-354)



Calibration of thread ring gauges
(TA-SU-313/LABC-70/TA-SU-354)



Calibration of thread plug gauges
(HPA-1/TEL6/3P/0.17-3.2/S6.5/LABC-15)



Calibration of external micrometers
(HPA-1/TULM14)

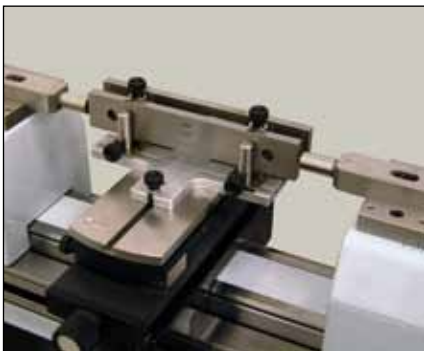

Comparative checking of gauge blocks < 250 mm
(TA-SU-313/TA-SU-305)



Comparative checking of gauge blocks > 250 mm
(TA-SU-313/TELMA7/P/TA-SU-305/TA-SU-306)



Setting of 2-point internal micrometers
(HPA-1/TELMA7/TELMN7.2)

LABCONCEPT + Premium

APPLICATIONS



Checking of dial indicators (TULM5C)



Checking of test indicators (TULM15)



Checking of snap gauges (TA-SU-313/TEL14N)



Temperature compensation system
TempComp

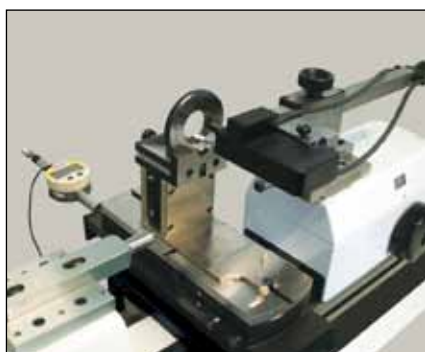

Checking of taper thread ring gauges
(HPA-1/LABC80)



Special design for measurement of
large taper threaded gauges



Direct measurement over the whole measuring range.