























More information on the website  
[radwag.com/en/info,w1,90N](http://radwag.com/en/info,w1,90N)

# AS 60/220.X2 PLUS Analytical Balance



The drawings, photos and graphics used are for illustrative purposes only.

## Functions

-  Autotest
-  Dosing
-  Percent Weighing
-  Parts counting
-  Peak hold
-  Formulation
-  Newton unit measurement
-  Statistics
-  Checkweighing
-  IR sensors
-  Under-pan weighing
-  GLP Procedures
-  Animal weighing
-  Density determination
-  Ambient conditions monitoring
-  Replaceable unit
-  Statistical Quality Control
-  ALIBI Memory
-  Mass for titrator
-  Wi-Fi

## Datasheet

Metrological parameters	
Maximum capacity [Max]	60 / 220 g
Minimum load	1 mg
Readability [d]	0,01 / 0,1 mg
Verification scale interval [e]	1 mg

<b>Metrological parameters</b>	
Tare range	-220 g
Standard repeatability [5% Max]	0,01 mg
Standard repeatability [Max]	0,06 mg
Standard minimum weight (USP)	20 mg
Standard minimum weight (U=1%, k=2)	2 mg
Permissible repeatability [5% Max]	0,02 mg
Permissible repeatability [Max]	0,1 mg
Linearity	±0,05/0,2 mg
Stabilization time	2 s
Adjustment	internal (automatic)
OIML Class	I
<b>Physical parameters</b>	
Leveling system	manual
Display	5" graphic color touchscreen
Protection class	IP 43
Delivery components	Balance, weighing pan, weighing pan shield, centring ring, bottom cover, power supply, fabric dust cover.
Weighing chamber dimensions	190×190×222 mm
Weighing pan dimensions	ø90 + ø85 (option) mm
Packaging dimensions	550×455×565 mm
Net weight	7,3 kg
Gross weight	9,3 kg
<b>Features of use</b>	
Database capacity	7
Touch-free operation	2 IR Sensors
<b>Communication interface</b>	
Communication interface	RS232 <sup>1</sup> , 2×USB-A (interchangeable), USB-B, Wi-Fi, Ethernet
<b>Electrical parameters</b>	
Power supply	Adapter: 100 – 240V AC 50/60Hz 0,6A; 12V DC 1,2A Balance: 12 – 15V DC 0,8A max
Power consumption max.	4 W
<b>Environmental conditions</b>	
Operating temperature	+10 ÷ +40 °C
Relative humidity	40% ÷ 80%

Repeatability is expressed as a standard deviation from 10 weighing cycles. Stabilization time depends on the ambient conditions and the dynamics of weighing pan loading; specified for FAST profile. 1 Barcode scanners, available as weighing instrument accessory, communicate with the instrument via RS232 interface exclusively.

\* Wi-Fi® is a registered trademark of Wi-Fi® Alliance.



## Accessories

Antivibration Tables  
Holders for laboratory flasks  
Barcode scanners  
Cigarette lighter receptacle power supply cables  
Density determination KIT  
USB cable (scale - printer)  
Professional weighing table  
Holders for test tubes and filters

Workstation for Pipettes Calibration  
Displays  
Protective cover for balances  
Weighing dishes  
Antistatic ionizer  
RS 232, RS 485 cables  
Under-Pan Weighing Rack  
RS 232 cables (scale - printer)

## Software

RAD-KEY  
Alibi Reader  
RADWAG Development Studio  
R.Barcode

LabVIEW Driver  
R-LAB  
E2R System

## Device dimensions

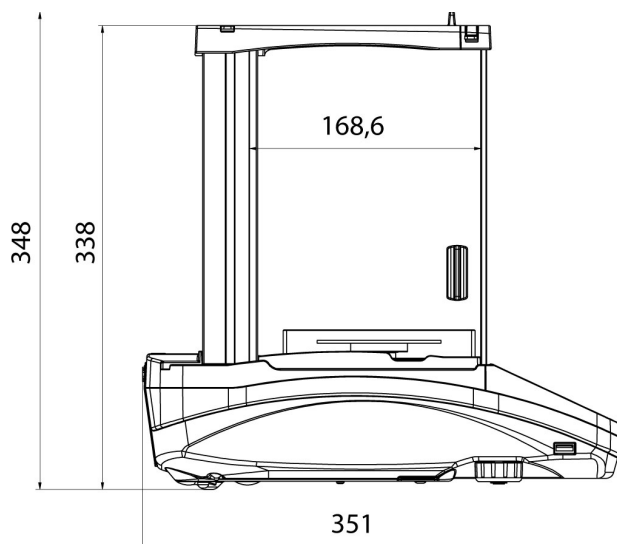
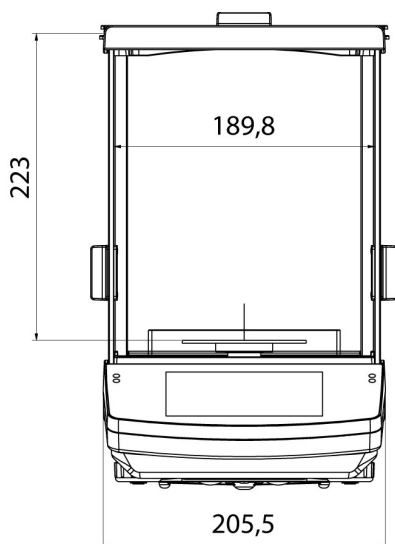

AS X2 PLUS, d = 0.01 mg

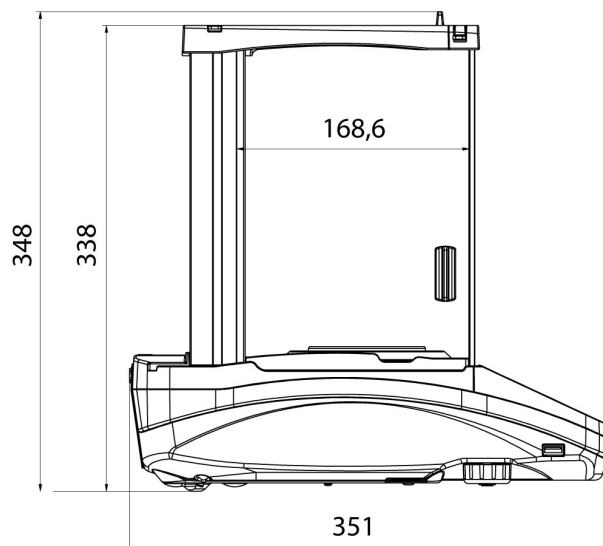
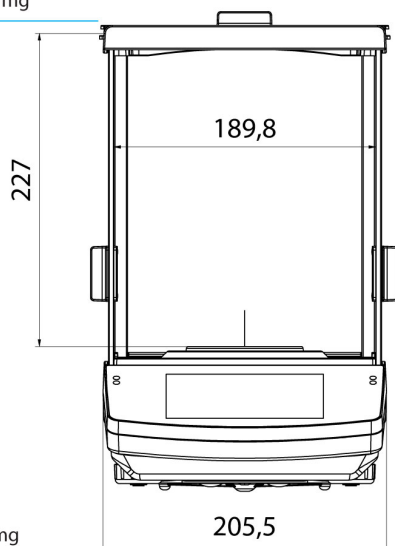

AS X2 PLUS, d = 0.1 mg